



Engineering Technology Group

Making Engineers Champions



WELCOME TO A
NEW KIND OF THINKING

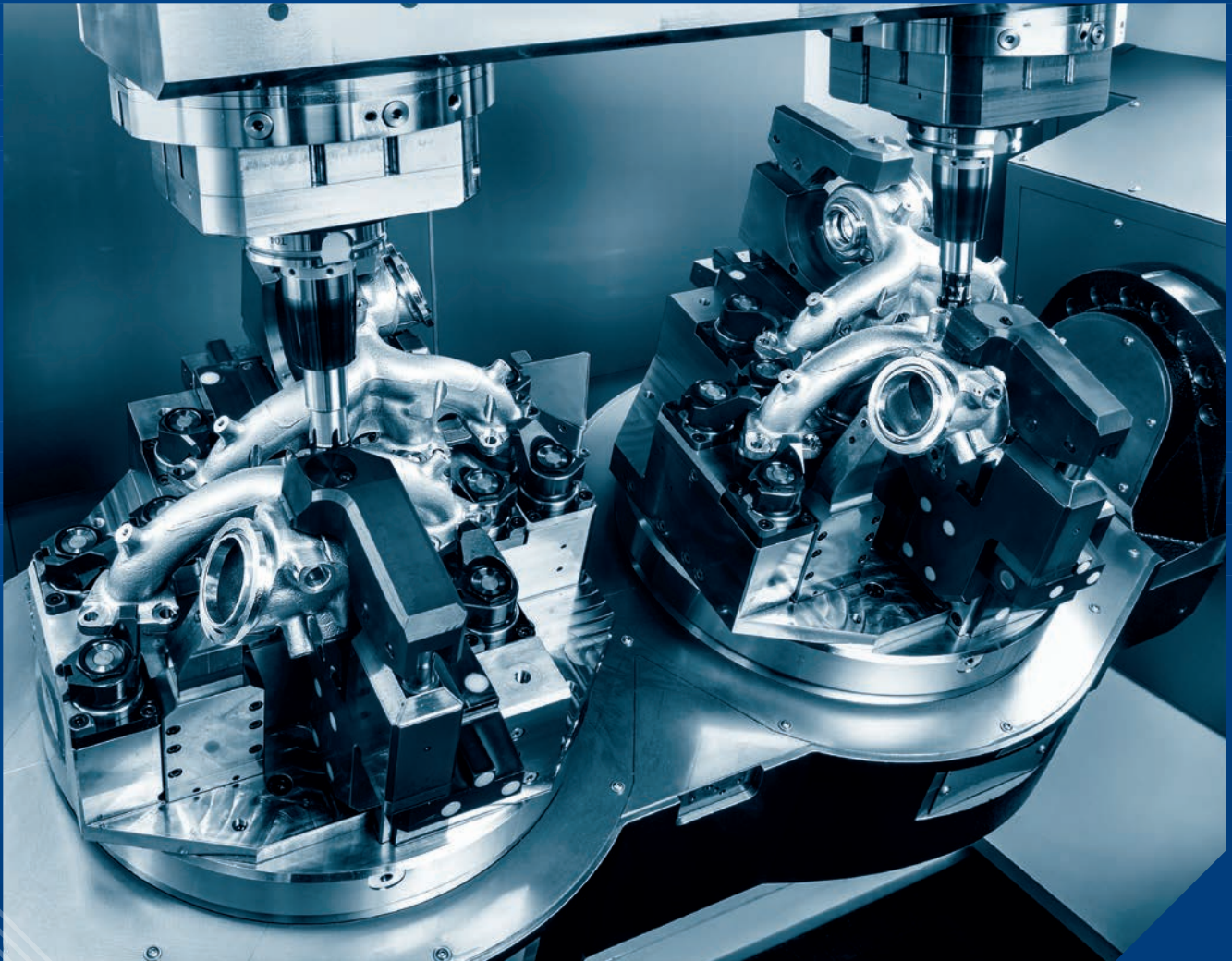

TABLE OF CONTENTS

04	Foreword from Martin Doyle, Group Managing Director		
06	About The Engineering Technology Group		
07	The Turnkey Solution		
08	Our Capabilities		
	09	10	12
	Technical Support	Training	Service & Spares
14	Our Structure		
	16	18	20
	ETG Headquarters	ETG Ireland	Hyfore Workholding
22	Our Associates		
	26	27	28
	Chiron	Nakamura-Tome	Quaser
	29	Mitsubishi Electric	
	30	31	32
	Vulcan	Winbro Group	OPS Ingersoll
	33	bavius	
	34	35	36
	Stama	Pietro Carnaghi	Kapp Niles
	37	Thielenhaus	
	38	39	
	Balance Systems	HK Laser	
40	Software		
44	Technical Partners		
45	Events & Promotions		
46	Net Zero Initiatives		



FOREWORD FROM MARTIN DOYLE, GROUP MANAGING DIRECTOR

Welcome to the Engineering Technology Group (ETG). I hope you enjoy perusing our brochure and it assists you in gaining a more informed insight into the structure of our business and the products and services we deliver as a Group Business.

ETG has been in a very fortunate position over the past decade, undergoing expansion year on year. During this period, we have massively increased our product and service offerings. Due to this rapid growth, the ETG business model, philosophy and ethos was at risk of dilution.

We, therefore, decided to perform a detailed examination of the company and consequently decided to restructure the business model. This has created a more efficient and streamlined business, a business that will pave the way for unsurpassed service levels for new and existing customers.

Our ever-evolving manufacturing business has been able to acquire HK Technologies while launching an entirely new brand of Vulcan machine tools. The new brands and technologies have been absorbed into the new business model and form an integral part of the company restructure and product offering.

As a company, ETG has for some time been an amalgamation of numerous business divisions that have all operated without maximising the full opportunities of a 'Group' structure. The restructuring, which has included the incorporation of HK Technologies into ETG, has created more significant synergies across the 'Group', streamlining administration, sales and service departments.



The restructure has created opportunities that have energised the sales force. The team now has a technology solution for every manufacturing business. Consequently, by giving our sales team complete access to the entire portfolio that includes everything from cost-effective to high-end machining, CAM, workholding, automation and software solutions plus many more, the opportunities are vast.

All product lines and solutions are supported by service, spares and an engineering team of experts that can deliver complete turnkey solutions. No other machine tool vendor caters for the industry as extensively as ETG. By amalgamating all business divisions, the opportunities are significant.

Our ability to respond to customer requests in the future regarding everything from dedicated service and application engineers to machine tool and complete turnkey solutions is something that has been significantly improved by the new business structure.

I extend an invitation for you to come and witness for yourself, the cutting-edge technology we deliver through our principal specific, turnkey machining cells. Our showrooms are located at our UK Headquarters in Wellesbourne, Warwickshire, Newbridge, Co. Kildare in Ireland and our manufacturing facility, Hyfore, is based in Coventry, West Midlands.

Our machining cells have dedicated software, bespoke and standard workholding, automation, robotics and more. By appointment, we can undertake comprehensive metal cutting demonstrations and look forward to welcoming you to our facilities.

A handwritten signature in black ink, appearing to read 'M Doyle'.

MARTIN DOYLE

**Group Managing Director,
The Engineering Technology Group**



ETG brings together the strengths of the world's most advanced manufacturers of high technology machine tools, automation, additive manufacturing, wire EDM and workholding systems to deliver highly productive and effective metal cutting solutions.

ETG brings a **new kind of thinking** to the machine tool market by providing in-depth technical support and applying unrivalled insight, experience and expertise. With this, ETG maximises the benefit from your new investment with a bespoke **manufacturing solution that is tailored to your needs**.

Our commitment is to offer exceptional customer service, in-depth product knowledge and factory trained support teams as well as on-going service. This is all delivered to the highest standards, as expected from our renowned associates.



Privately owned independent company, established in 1996.



Offering the UK and Ireland the largest range of: CNC milling & turning, Wire EDM, 3D/additive manufacturing, balance machines, micro-finishing machines, gear grinding machines and subcontract laser marking.



3 sites based in the UK & Ireland: ETG Headquarters, ETG Ireland and Hyfore Workholding



Key Market Sectors: Aerospace, Medical, Rail, Defence, Energy and Telecommunications, General Subcontract, Automotive (with specific focus on EV in this sector).

THE TURNKEY SOLUTION PROVIDER



EVALUATE

We assess all variables during an evaluation process, such as your current and future requirements, the machine specification and workholding through to automation and software. ETG utilises its vast experience to deliver the best manufacturing solution, increasing productivity and profitability for your business.

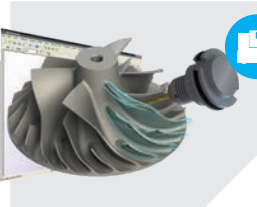

DESIGN

ETG will design and implement a machining process that will allow you to work faster, more efficiently and at lower operational costs. We can create a process strategy that factors in clamping positions/axes, machine-tool compatibility, cutting tools, loading, automation and of course, the operator.



CAPABILITY

ETG can provide a complete turnkey solution to match your production requirements whilst enhancing cycle times and component quality. This capability is achieved through feasibility studies and collaborative working to determine the optimal tool-selection, automation, software, CNC programming, collision checking, measuring and prototype testing.



IMPLEMENTATION

Once ETG has fully tested the turnkey concept, we will implement and deliver the machining cell, on schedule and to budget. Training will be delivered on-site or at the ETG headquarters in Wellesbourne.



AFTERCARE

Once your turnkey solution has been delivered, ETG will remain your trusted partner. ETG will deliver comprehensive aftercare as well as service and scheduled maintenance support from our large team of skilled service engineers. All this is underpinned by an in-house facility that is stocked with OEM spare parts, keeping your machines running smoothly and efficiently.

OUR CAPABILITIES

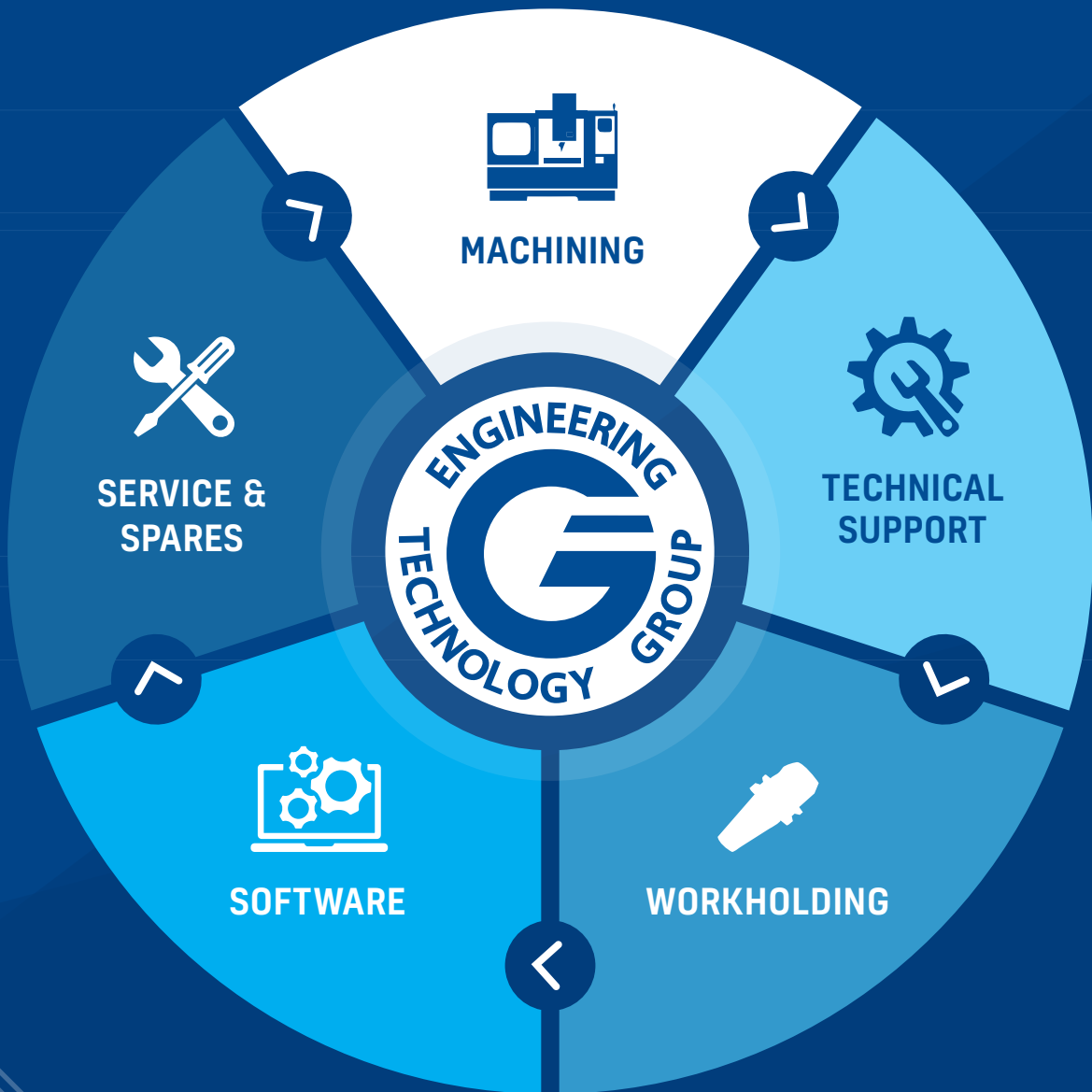

TECHNICAL SUPPORT



Machine tool solutions often require optional equipment such as bar feeds or automation. Working closely with its technical partners, ETG installs and tests all relevant equipment, managing faster machine delivery and integration to ensure optimum cycle-times, without having to rely upon a third-party engineer to arrive from abroad.



TURNKEY DESIGN & IMPLEMENTATION



RETURN ON INVESTMENT STUDIES

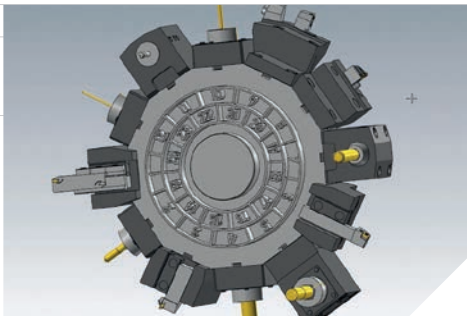

ENGINEERING & MANUFACTURING DESIGN



PROCESS & PRODUCTIVITY IMPROVEMENT

Technical support also offers:

- Cost per part studies
- Project/part support
- Research & development
- Part prove-outs



TECHNICAL SUPPORT: TRAINING

At ETG, we have moved beyond simply supplying machine tools. We also provide complete turnkey solutions and a critical element of this is training. We are able to equip our clients with all the skills they require to realise optimum return on their investments.

Under this, we ensure clients are adequately trained to make the most of everything from software to machinery, utilising our state-of-the-art, dedicated facilities to provide applicable hands-on training.

Learning can be tailored to the specific needs of the customer with the option of an additional suite of personally developed courses.

Supporting us with advanced training, are our industry-leading technical partners whose products and expertise have been made available to aid clients in their processes.

In addition to client training services, ETG has partnered with In-Comm to provide apprentice training for the next generation of engineers. We are investing in the future of the industry.

In-Comm is one of only a few training providers to be rated 'Ofsted Outstanding' and the Engineering Technology Group is proud to maintain our forward-thinking strategy and working relationship with them.



Apprenticeships

Through In-Comm, ETG is investing in the future of engineering, making important steps to bridge the industrial skills gap and train the engineers of tomorrow.

Future engineers are trained using the most advanced machines and technology available. Learners are provided with the chance to apply their theoretical learning on live manufacturing projects, putting learners ahead of their peers when completing conventional courses.

Apprentices are also provided with the opportunity to progress to degree level, without the need to undertake the financial burden of university study.

Access To Technology

Over £6m of machinery and technology has been installed at training facilities across the UK and we want to make sure that the entire supply chain benefits. With this in mind, we are encouraging SMEs to get in touch if they would like to hire time on one of the machines to carry out prototyping or advanced manufacturing work that would otherwise be too costly.

Upskilling

For the UK manufacturing sector to retain its position as a world leader, upskilling is vital. Manufacturers must be kept abreast of the latest developments and given the opportunity to develop their existing skills and that of their staff.

ETG is committed to continuous upskilling for long-term clients. This is provided both in house at our advanced facilities, at client sites or through our partnership with In-Comm.

All training is supported by our technical partners, enabling learners to utilise the very best the industry has to offer.

ETG Demonstration Facilities

Our advanced facilities in the UK and Ireland allow us to fully demonstrate our selection of industry-leading machining solutions.

This is reinforced through our partnership with In-Comm, enabling clients to engage, learn and achieve the highest possible standards.

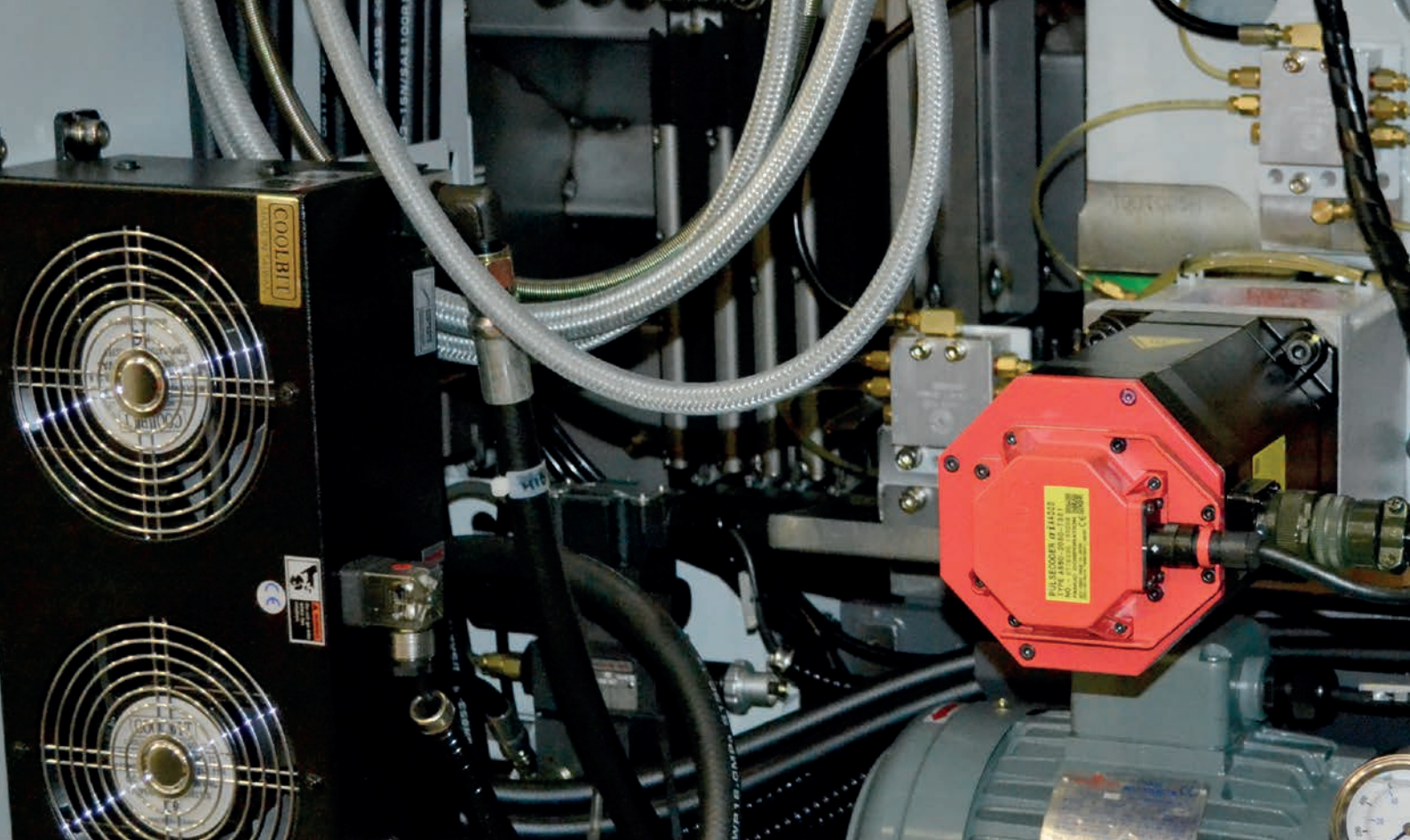

／ SERVICE & SPARES



Once a machine is installed, it's essential to keep your spindle turning. Part of ETG's philosophy is delivering machine lifetime support. With its dedicated service team, comprising of over twenty associate-factory-trained engineers, you will be assured of optimum production efficiency.

The service and technical support division endeavours to exceed customers' expectations with first-class support tailored to the brands that ETG offers.

- Breakdown support (24hr response)
- Machine health checks
- Telephone support
- Customer feedback/continuous improvement
- Dedicated and experienced spares support team
- 24hr response on in-stock items
- 1,000's of stock items held at ETG HQ



Support Agreements

Our Support Agreements allow customers to subscribe to a number of hours per year, allowing you to spread your service liability and achieve reduced costs. Our Support Agreements have 4 levels ranging from Bronze (50 hours per year) to Platinum (300+ hours per year) and give customers significant savings on hourly rates over those without any level of support.

- Support Agreements can be used for servicing, breakdowns, applications, technical and training support.
- Invoiced monthly and payment spread annually by Direct Debit
- One off payment option
- Gold and Platinum support packages do not incur hourly travel costs
- Silver, Gold and Platinum support packages do not incur overnight charges
- Silver, Gold and Platinum support package receive 15% discount on spares
- Extra top-up hours available
- Banked hours can be used to support equipment not supplied by ETG*
- Technical and application support includes, audits, reports and project plans

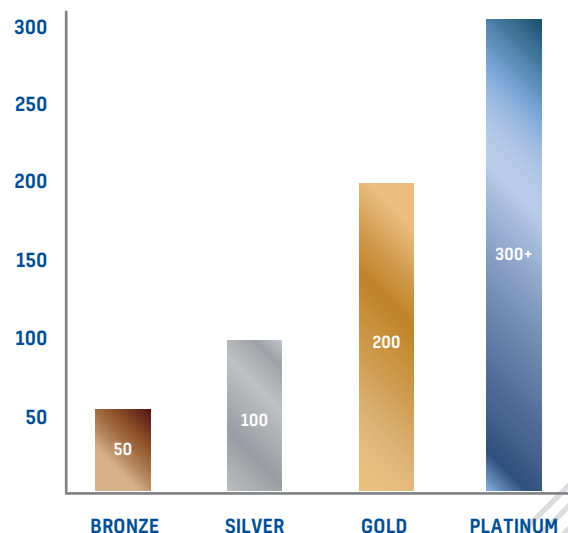

**At ETG's Operations Manager discretion*

OUR STRUCTURE



ETG HEADQUARTERS

The Group headquarters encompasses the operations division, the engineering team, field sales activities, technical, pre-sales and internal sales support, spares, applications, project management and pre-delivery inspection, goods inward and despatch.

HYFORE WORKHOLDING

Hyfore Workholding, ETG's workholding division, has its own in-house team of engineers to design and create bespoke and standard workholding. The manufacture, prototype testing and measurement of workholding solutions are also all completed at its Coventry production facility.

ETG IRELAND

ETG Ireland replicates all of the services of the group, offering machine sales, service, technical support and all aspects of training, serving both the Republic and Northern Ireland from our facility in Newbridge, Co. Kildare.



ETG is structured into three divisions; UK Headquarters, ETG Ireland and Hyfore Workholding. Each has a clear objective, but all ensure the end-user receives the highest level of service.

Primary business activities are conducted in the United Kingdom and Ireland. UK operations are based at ETG's Headquarters in Wellesbourne, Warwickshire, while Ireland is serviced from Newbridge, Co. Kildare.



 WELLESBOURNE, WARWICKSHIRE, UK
 ENGTECHGROUP.COM



 COVENTRY, WEST MIDLANDS, UK
 HYFORE.COM / HYFORE.SHOP



 NEWBRIDGE, CO. KILDARE, IRELAND
 ETGIRELAND.IE



ETG HEADQUARTERS

ETG is based at its established 17,500 sq.ft. facility located in Wellesbourne, Warwickshire. The Group has extensive and proven expertise in turnkey engineering and automation solutions, offering industry experience and capability from one source.

We possess advanced engineering and management skills that encompass programming, logistics, systems integration and project management - all necessary to analyse, design and install the optimum solution.

ETG takes total care of machine preparation prior to customer delivery. This dedicated team are ready for any challenge, be it a "direct from stock" standard machine or a complex bespoke turnkey solution that encompasses design, technical applications such as

automation, engineering processes and cycle-time testing through to final acceptance.

With ETG's servicing and spare parts department also being based in-house you can be assured of the broadest range of machine tool spares and seamless technical support that is available to the UK and Irish manufacturing communities.





GOODS INWARD

Machine tools from ETG's associates arrive from many locations around the world. ETG have a dedicated unloading and handling operation, once a machine has passed PDI and is ready for despatch, the engineering teams then deliver it to the customer's site and assist with installation and machine tool or turnkey solution set-up.



PRE-DELIVERY INSPECTION (PDI)

ETG has a dedicated PDI team which is integral to delivering a seamless installation. In effect, a newly installed machine is delivered as near to 'plug-and-play' as possible. Undertaking PDI's and pre-delivery engineering work reduces lead times and simplifies installation.

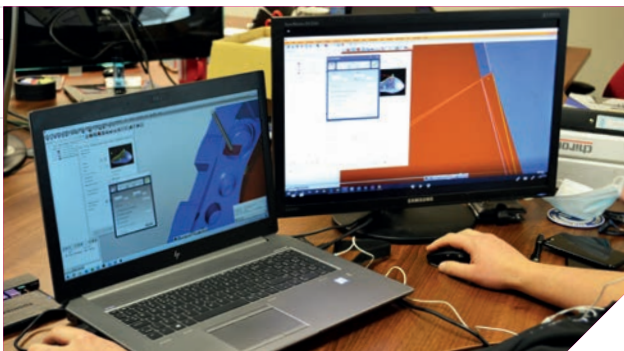

TECHNICAL SUPPORT

ETG technical support offers a wide variety of services including, but not limited to; turnkey design and implementation, return on investment studies, cost per part studies, research and development and part prove outs.



SERVICE & SPARES

ETG machine tool spares department holds extensive inventories of machine tool spares and parts across all of the associate brands it represents, ensuring original manufacturer parts are available with rapid delivery.

ETG IRELAND

ETG - Ireland brings a new perspective to machine tool supply and support. ETG expanded its highly successful operations to cover all of Ireland in January 2014.

Representing all the leading machine tool brands that are available within the group portfolio, coupled with an impressive software supply that is spearheaded by Mastercam & Cimco, training and support is delivered from its base in Newbridge, Co. Kildare. The support of the group operations including PDI, 20+ dedicated service engineers, service aftercare and spares are all available.

Being experts in applications engineering, CAD/CAM programming and project management means that ETG Ireland can deliver complex turnkey packages ready to go straight into production. This expertise is combined with 24/7 support, training and preventative maintenance to keep customers operating at maximum productivity levels.





▲ The annual ETG Ireland Smart Factory Machining event

Cost Effective, Hands On Software Training

One of the services offered by ETG is comprehensive software training based on its Mastercam expertise as well as ISO training and refresher courses for FANUC, Siemens and Heidenhain programming systems.

The training school can accommodate up to six operators at any one time and is fully equipped with PCs. The facilities are unique for two reasons, not only can those on the course become acquainted with the turning, milling and mill-turn features of Mastercam software, but they can also put their newly learnt programming skills into live action via the machining centres.

In effect, a whole production workshop can be simulated across a typical two-day course, giving opportunities for those just beginning with a low knowledge base to others looking to upgrade their skill-set or wishing to undertake a refresher course.

Courses can be tailored to a specific need and ETG are happy to accommodate groups or individuals dependant on the requirement.

ETG Ireland's Trusted Software Associates



HYFORE WORKHOLDING



Hyfore Workholding is a leading supplier of workholding and machine accessories, offering a comprehensive range of standard products to bespoke fixtures. Hyfore Workholding has the capacity and skills to manufacture a wide range of manual and automatic workpiece holding and handling systems for the manufacturing industry.

Hydraulic fixtures and standard workholding is the core business focus at Hyfore Workholding Limited. The company was established in January 2001 and since its inception, the company has experienced continuous growth and currently employs over thirty dedicated, highly-trained professionals at its design and manufacturing facility in Coventry, West Midlands. Being centrally located, Hyfore is strategically positioned to service engineering businesses throughout the United Kingdom and

Europe. Hyfore Workholding considers itself the UK's premier bespoke hydraulic fixtures and standard workholding specialist - a company that can provide both simple off-the-shelf solutions through to bespoke workholding systems that have been designed and manufactured to customer specifications. Contact Hyfore to find out how we can reduce your set-ups and non-cutting times and improve your productivity through bespoke quality hydraulic fixtures and standard workholding.

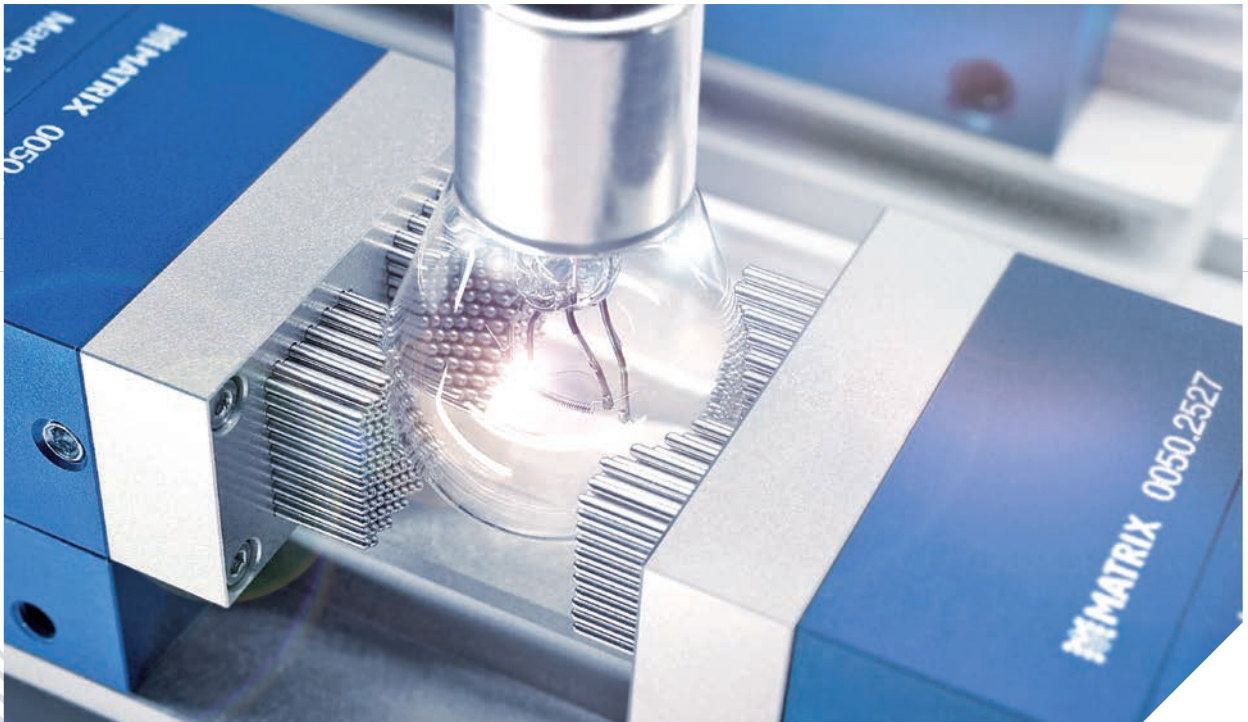



Getting the Most Out of CNC Machines

Hyfore Workholding can assist its clients in realising significant savings in medium and high-volume CNC production, using cost-effective bespoke workholding systems that help increase machine performance.

Hyfore Workholding specialises in the design and manufacture of high-quality, bespoke workholding systems for metal cutting, welding and assembly applications.

Cost-Effective Bespoke Design

Hyfore Workholding's highly qualified specialist engineers are dedicated to provide complete solutions to customers' manufacturing requirements and offer complete turnkey solutions including:

- Mechanical and electronic design utilising CAD/CAM 3D modelling. This capability gives us a clear advantage when viewing complex fixtures and tool cutter paths, in relation to the fixture design.
- Quality testing and prove-out to agreed standards
- Project management
- After-sales service support
- Simultaneous engineering contracts

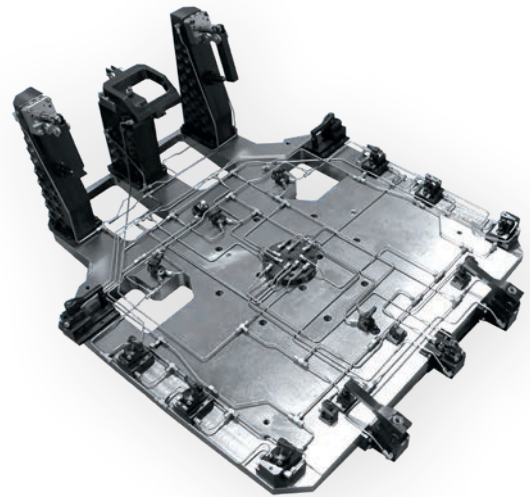

Our Trusted Associates

OUR ASSOCIATES



INCLUSIVE SUPPORT FOR EXCLUSIVE BRANDS



VULCAN

A photograph of a large industrial machine tool, a vertical machining center (VMC) model VMC 850E, with the Vulcan logo on its side.

WINBRO GROUP
technologies

A photograph of a laser cutting machine in operation, with a bright laser beam cutting through a metal sheet, creating a shower of sparks. The machine is a white cabinet-style unit.

OPS INGERSOLL
Go for performance

A photograph of a large industrial machine tool, a vertical machining center (VMC) model Eagle V, with the Ingersoll logo on its side.

bavius

A photograph of a large industrial machine tool, a vertical machining center (VMC) model 300, with the Bavius logo on its side.

OUR ASSOCIATES



✓ INCLUSIVE SUPPORT FOR EXCLUSIVE BRANDS

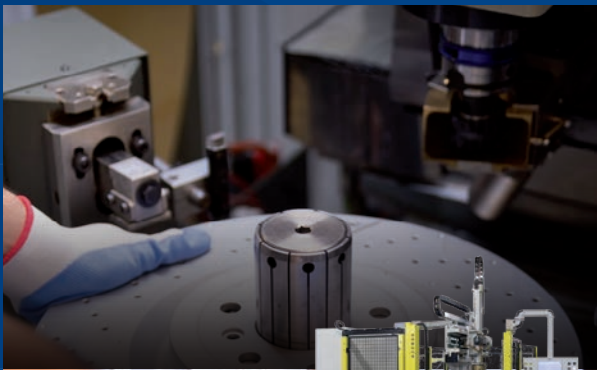

 **Balance
Systems**

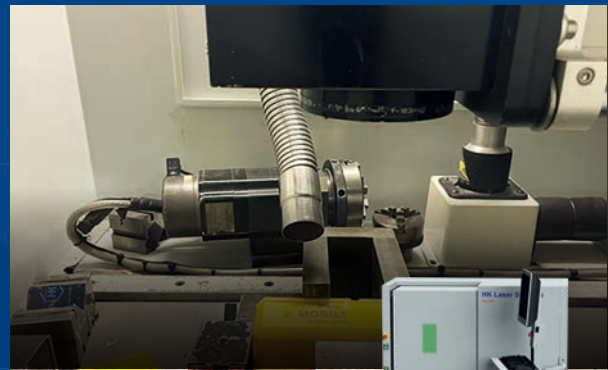

 **LASER**





chiron



The CHIRON range of vertical machining centres offer exceptional productivity and a wide choice of 5-axis, twin-spindle, swivel head and two axis rotary table options.

The emphasis on high speed axis travels combined with accuracy, stability and reliability make CHIRON machine tools highly suited to high volume applications, automated cells and turnkey installations where maximum productivity is a primary consideration.

Through a lengthy history with the CHIRON brand, ETG is uniquely placed to provide a full range of CHIRON machining centres and turnkey solutions. CHIRON is one of the metalworking industry's first choices across small, medium and large-scale engineering and manufacturing environments.

◀ Client factory visit of Chiron head office, Tuttlingen, Germany

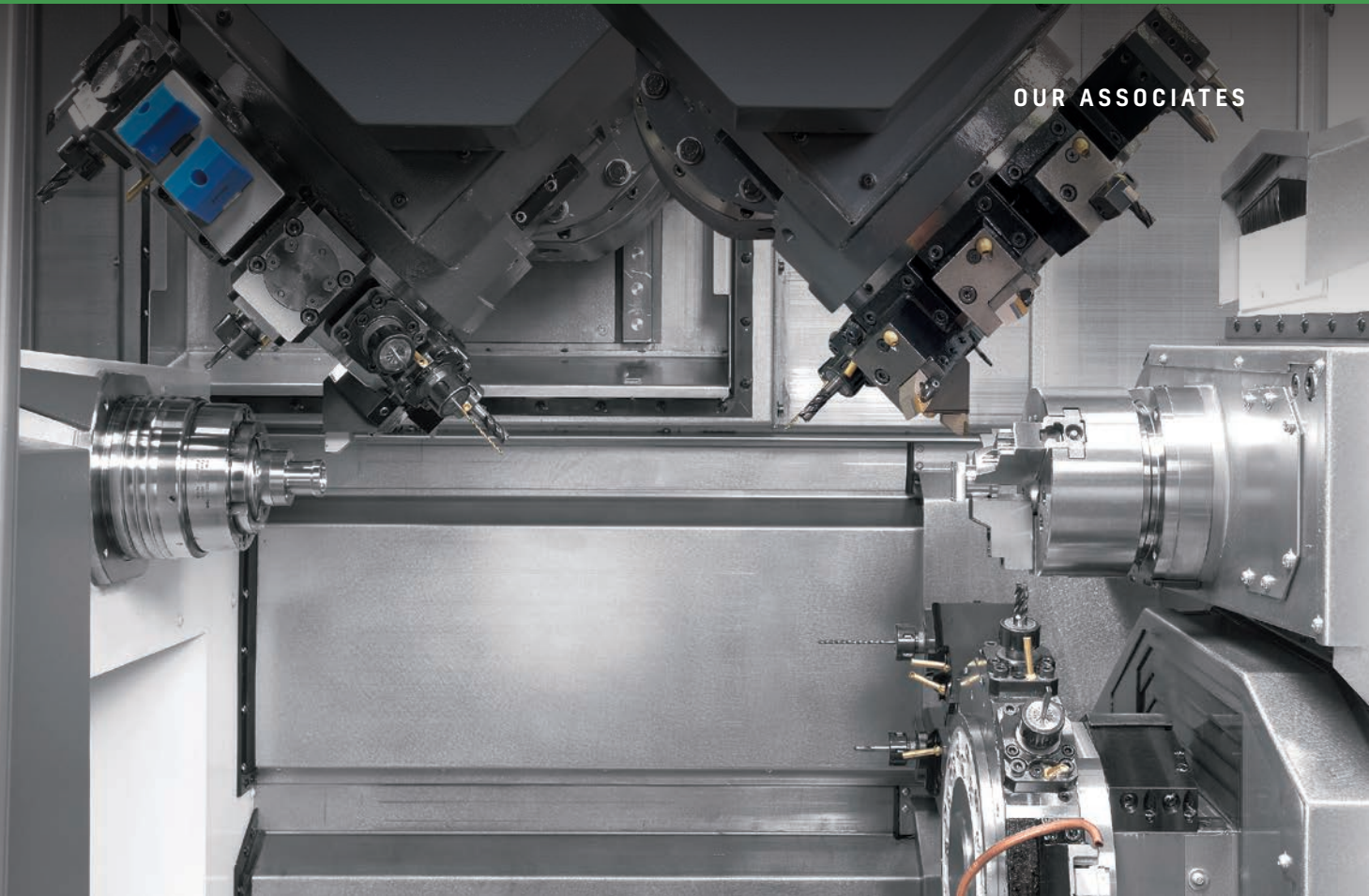

Nakamura has established a firm position as a world leader in the design and manufacture of single process multi-tasking mill/turning machines, developing products by utilising innovative technologies fostered in other machines such as high precision CNC lathes and machining centres.

Nakamura twin spindle machine tools with multiple tool turrets or tool changers offer high-torque power driven tools that give the flexibility and capability for machining the most complex mill/turned components in a single set up.

◀ Nakamura-Tome Head Office, Kanazawa, Japan



Quaser horizontal, vertical and multi-face 3 and 5-axis machining centres are increasingly popular due to their superb build quality and suitability for high volume production, tool room and subcontract machining environments.

All UK sales, service and customer support activities for Quaser products are handled through ETG, working closely with the Taiwan manufacturing facility and the Swiss based Quaser European Technology Centre.

The Quaser ranges of MV and MF vertical machining centres are highly versatile, offering high speed, high powered machining with 4+1 and full 5-axis machining capability along with large X-axis machines with a compact footprint.

◀ Quaser Head Office, Taichung, Taiwan

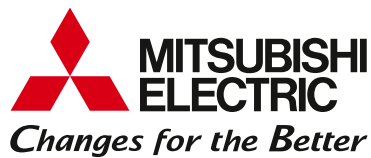

More than 30 years ago, Mitsubishi Electric developed and produced the world's first electro-erosive machine (EDM). Today, Mitsubishi Electric is the world-leader in wire EDM technology, continuing an uninterrupted chain of development dating back to the 1950s.



Mitsubishi Electric machines are produced to the highest standard in high specification conditions at their Germany-based facility.

ETG is the UK's sole distributor for Mitsubishi Electric wire EDM machines, providing its clients with exclusive access to the very best EDM technology available.

◀ Mitsubishi Electric Head Office, Ratingen, Germany



Welcome to the Vulcan range of machine tools from the Engineering Technology Group - machines with pedigree DNA.

ETG always delivers innovative machine tool solutions to the manufacturing industry. Through our offering, our clients' needs have always been catered to, but we always strive to offer more. To this end, we are proud to introduce the Vulcan range of robust and capable machining centres and turning centres, offering exceptional quality at an affordable price.

ETG employs dedicated Vulcan staff that are permanently based at the production facility. This allows us to directly impart our industrial knowledge and produce a machine tool range that delivers performance and precision to incredible degrees of excellence.

◀ Vulcan, ETG, Wellesbourne, United Kingdom



Winbro high-technology machine systems produce cooling holes and forms in critical components for applications such as aero engines, industrial gas turbines and semiconductor manufacturing.

Winbro non-conventional machining processes include High Speed EDM Drilling, Laser Drilling, Cutting & Ablation, ECM (Electro Chemical Machining) and Grinding. Our machine systems can be configured either as single process or dual complimentary process machines, many of which are unique, providing a no-compromise solution to industry machining requirements.

◀ Winbro Group Head Office, Leicestershire, United Kingdom



Based in Burbach, Germany, OPS INGERSOLL manufactures a highly-developed series of EDM, HSC and automation machinery for the industrial metalworking sector.

Driven by a unique company view and a focus on quality and innovation, OPS INGERSOLL have amassed a wealth of industry expertise, something that is evident within each of their product lines.

The OPS INGERSOLL brand demonstrates unsurpassed levels of precision, speed and performance. If you need to take your machining performance to another level, the OPS INGERSOLL range is fully aided by ETG's turnkey offerings.

◀ OPS INGERSOLL Head Office, Burbach, Germany



bavius specialises in large format machining centres primarily for the aerospace industry. These products offer massive productivity gains in comparison to traditional machining methods and processes.

Ranges include five axis horizontal, profile, gantry and universal machines for large scale aerospace components – notably the HBZ AeroCell and HBZ CompactCell horizontal machining centres.

◀ bavius technologie Head Office, Baienfurt, Germany





Stama Maschinenfabrik is a German machine tool manufacturer and a sister company of Chiron. It specialises in advanced 4 and 5-axis machines as well as single, twin and 4-spindle vertical machining centres and mill-turn centres.

Offering flexibility and high production efficiency for everything from small batch to high volume machining, the Stama range has inherent reliability and automatic loading options that makes them well suited to unmanned machining environments and heavy duty machining.

◀ Stama Head Office, Germany

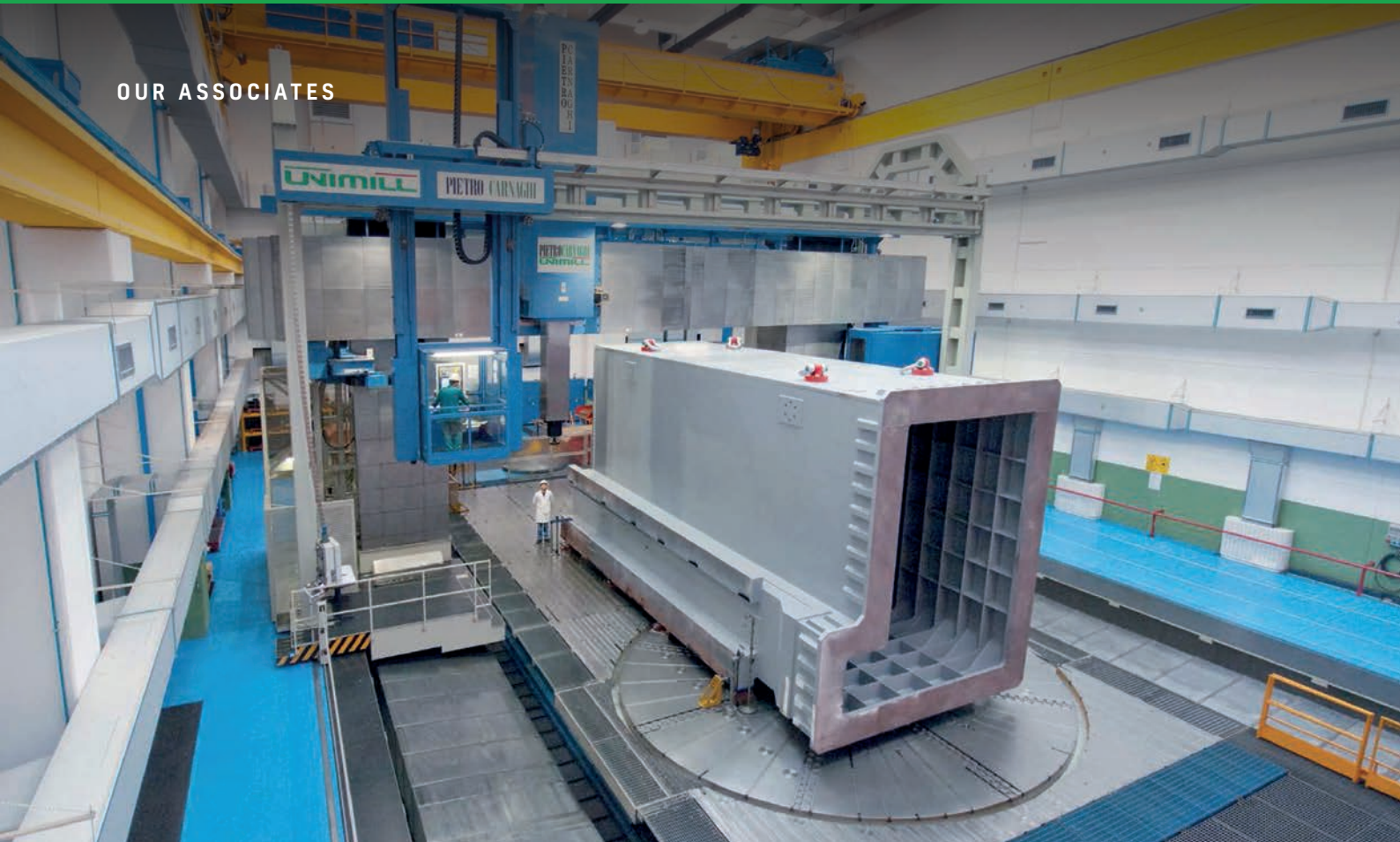
OUR ASSOCIATES



PIETRO CARNAGHI
Machine Tools



The Pietro Carnaghi company was founded in 1922 and is renowned on the international scene for the manufacture of large-scale machine tools and the subsequent components. With more than eight decades of experience in the sector, this brand of machine tools demonstrate innovation, quality and astounding productivity levels on large components.

Pietro Carnaghi specialises in the manufacture of machine tools for industry sectors where high performance is a necessity. The company produces vertical lathes, movable portal milling machines – Gantry type and Flexible Manufacturing Systems (FMS) cells.

◀ Pietro Carnaghi Head Office, Cortese, Italy



With a legacy dating back to 1898, Kapp Niles is Germany's leading producers of gear grinding machines.

Through ETG, clients are able to experience exceptional quality and an unrivalled level of precision and technology that guarantees performance you can rely-on when it comes to niche machine tools for gear grinding.

◀ Kapp Niles Head Office, Coburg, Germany



THIELENHAUS MICROFINISH



Enabling the manufacture of extreme levels of precision finish, Thielenhaus microfinish technology has played a hand in putting human beings on the moon. This brand is now available to ETG clients.

Thielenhaus' eternal claim to fame is their micropolishing of miniature bearings used in the construction of the Apollo 11 spacecraft that took the first astronauts to the Moon in 1969.

To this day, Thielenhaus continues to produce exceptional quality microfinishing technology.

◀ Thielenhaus Head Office, Novi, USA

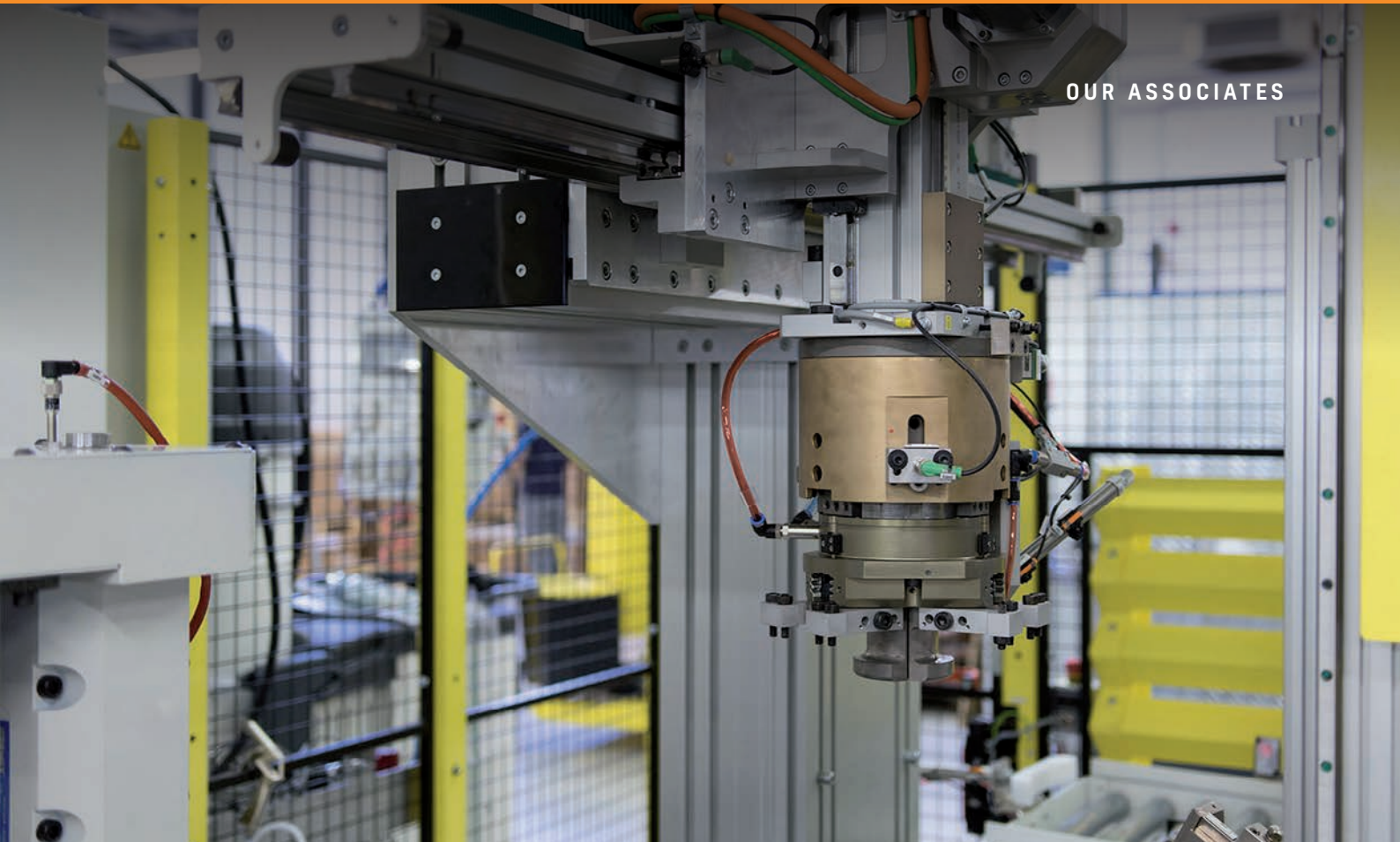

At ETG, we offer a complete range of cutting-edge balancing machines from Balance Systems, makers of quality since 1974.

Based in Italy, Balance Systems create leading edge balancing machines for rotating components. They specialise in the development of advanced technology, applying it to their industry portfolio. Mass imbalance is one of the most common performance issues faced when using rotating machinery. Imbalance causes unwanted vibrations and mechanical stress, as well as increasing the energy consumption and noise levels of the machine. Balancing machines solve these problems, improving production performance dramatically.

Their advanced offering is available to ETG clients as a component of their complete turnkey offerings.

◀ Balance Systems Head Office, Pessano con Bornago, Milan



For customers of the Engineering Technology Group (ETG), the HK Laser division offers the technology and services to accommodate all of your component marking requirements.

In a manufacturing industry where conforming to quality and legislative standards and obligations are ever more critical; the components and assemblies that constitute a final product now demand traceability.

HK Laser specialises in laser marking systems that generate fast, efficient and precise component marking that conforms to all your requirements, regardless of industry sector. Laser marking has rapidly become the preferred method of permanent non-contact marking as it offers quality, precision and speed with low running costs – now ETG can provide this service to your business.

◀ HK Laser, ETG Headquarters, UK

SOFTWARE CAPABILITIES

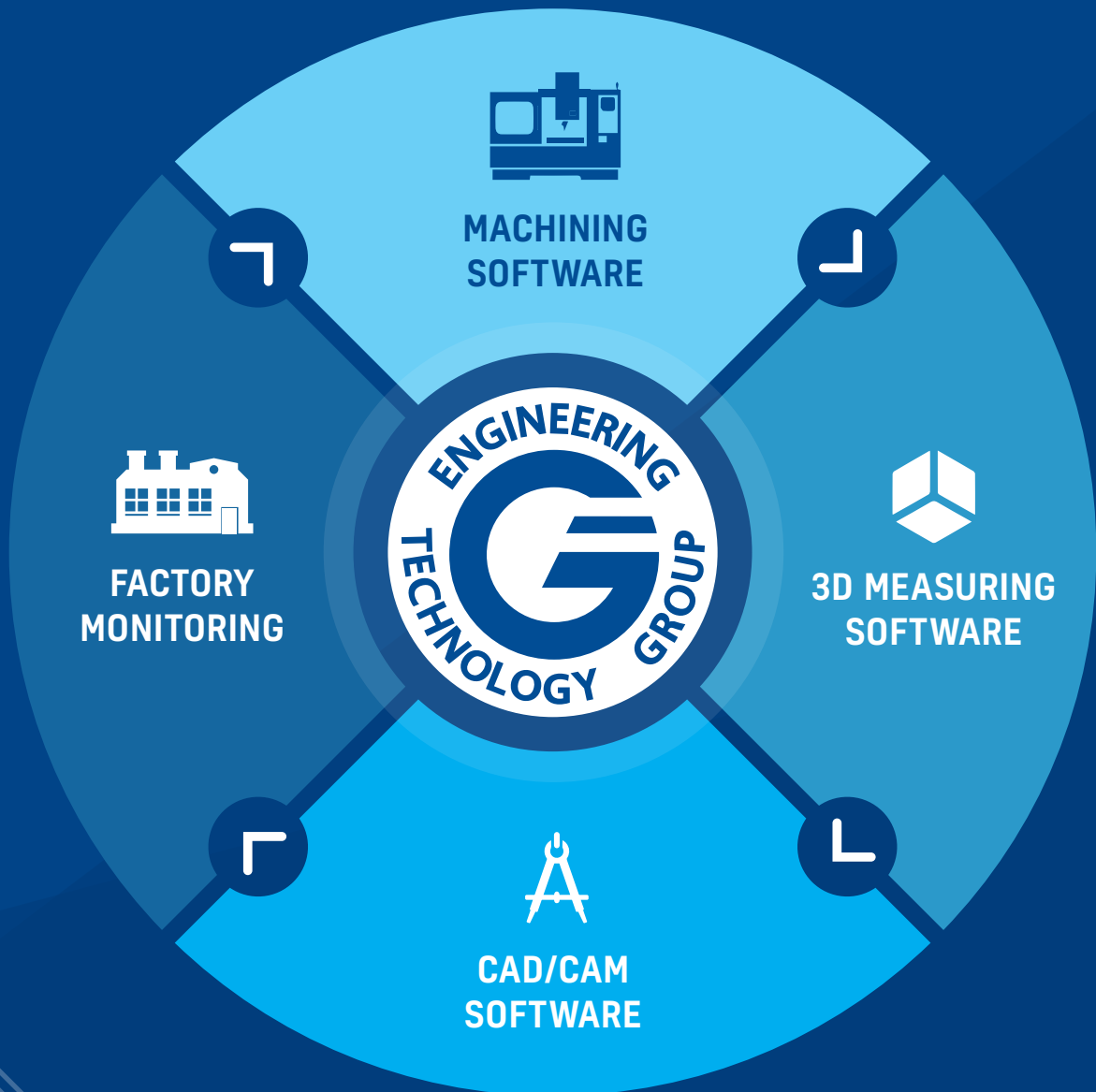

／ MACHINING SOFTWARE



HEIDENHAIN

For more than 40 years, HEIDENHAIN have proven themselves every day with CNC control technology that is proven in the machine tool industry.

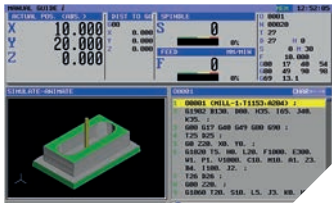

FANUC

Whether you are fully embracing IoT and Industry 4.0 or simply looking to make it easier to manage the data on your CNC, FANUC has software solutions to get you the information you need.



SIEMENS

Used globally on highly accurate machine tools, Siemens latest control gives you the ability to reduce production times on CNC machines with the latest features and cycle definitions.



The latest M800 EDM control reduces setup and programming times for machine tool users. Being highly operator friendly and unique to the market, Mitsubishi embraces Industry 4.0 to constantly manage all data.

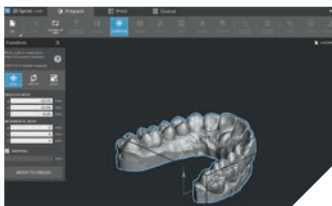

Plastic additive manufacturing software. Experience true productivity with exclusive additive manufacturing software for 3D Systems plastic printers.

3D MEASURING SOFTWARE

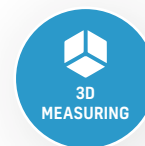

Verisurf, model-based inspection and measurement software provides one common metrology platform for all 3D measuring devices.

CAD/CAM SOFTWARE

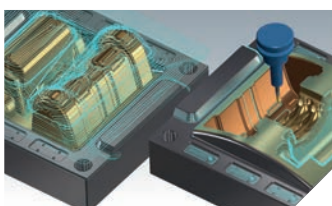

ETG is an authorised Mastercam supplier and delivers CAD/CAM software tools for all types of programming, from the most basic to the extremely complex. Mastercam offers leading solutions for designers and NC programmers in a spectrum of industries including milling, turning, wire EDM, router programming, plasma cutting, lasers, and 3D design and drafting.



ETG is the UK and Ireland's exclusive supplier of CAMplete software, allowing clients to extract optimal usage from their machining processes and equipment. The advanced software capabilities allow operators of complex, multi-tasking machinery to use their machines to their full potential.



hyperMILL® is the high-performance, complete CAM solution from OPEN MIND. 2.5D, 3D, 5-axis milling and mill/turn tasks can be programmed perfectly and precisely with hyperMILL®. A modular and flexible CAM solution for 2.5D, 3D and 5-axis milling as well as mill turning and machining operations such as high-speed cutting (HSC) and high-performance cutting (HPC), with everything integrated in a single interface.

FACTORY MONITORING SOFTWARE

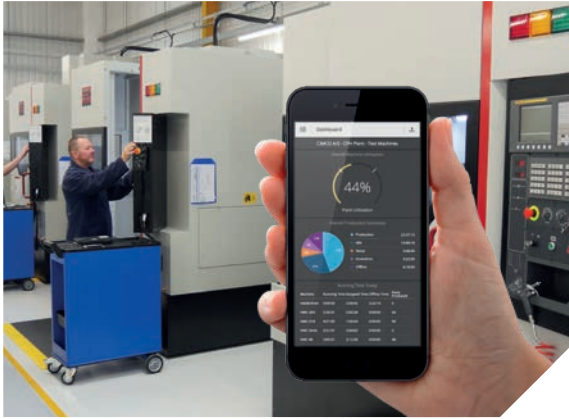

ETG is the UK and Ireland's exclusive supplier of CIMCO CAD/CAM software products, brought under our turnkey solutions offering.

Divided into five key elements, CIMCO offer a complete range of advanced CAD/CAM software products. These key elements include:

- CIMCO DNC-Max 7
- CIMCO MDC-Max 7
- MDC-Max Web Client
- CIMCO NC-Base 7
- CIMCO Edit 7

For each of these, ETG supplies a full selection of product training, ensuring users are able to make the most of their investment.



B-Safe X for plant and maintenance manager. Monitor, protect, maintain and evolve your machine tools thanks to the easy installation of our innovative B-Safe sensor.

The presence of a microprocessor with memory allows the local detection and storage of collisions, unbalances and overloads phenomenon as well as machining anomalies, tool wear and bearings diagnostic.

The wide range of integrated functions makes it a standalone solution, valuable for your asset protection, production monitoring and preventative maintenance.

The retrofit installation does not require machine software modification.

TECHNICAL PARTNERS

ETG are supported by select world-class Technical Partners. The expertise and technology competence of these partners is essential in the delivery of world class and complete turnkey solutions.







▲ A snapshot of the Open House Event, "Discover Turnkey Excellence" at ETG's headquarters in Wellesbourne, UK.

KEEP UP TO DATE WITH ETG

Join our social media channels



-  Like us on Facebook /engtechgroup
-  Follow us on Twitter @EngTechGroup
-  Follow us on LinkedIn: ETG UK & Ireland
-  Subscribe on YouTube: ETG UK and Ireland

Get the latest offers and news



Our weekly broadcasts give generous discounts on showroom machines with limited hours of use and come on a first come, first served basis.

Scan QR and enter your details to start receiving offers and updates.



ENGINEERING A GREENER WORLD

With net zero initiatives

Global warming has been on the radar for many years, it has been talked about endlessly and debated by world leaders, on how the issue should be tackled. A legally binding international treaty on climate change was adopted in 2015 and entered into force in November 2016 – The Paris Agreement.

With the above in mind, and in collaboration with Betterworld.Solutions, who are leaders in the green revolution, ETG pledge to offer Net Zero initiatives to its customers. See the opposite page for the first of many Net Zero Initiatives from ETG. Further exciting green initiatives will be rolled out to our customers imminently - watch this space!

Look on the next page to see our first Net Zero Initiative, the Amorphous Core Transformer and to see how much money and energy you could save.

AMORPHOUS CORE TRANSFORMERS

What is an amorphous core transformer?

As part of ETG's commitment to achieve Net Zero and support our clients to do the same, we would like to introduce Amorphous core transformers in collaboration with Powerstar, that can be fitted to all machine tools (both old and new).

Due to the cost of energy only going in one direction, there are considerable financial savings when fitting an Amorphous core transformer and with the decrease in power usage comes a significant CO₂ reduction, limiting the damage to our environment.

How much CO₂ and energy savings can you achieve by fitting an amorphous core transformer to your machine tool?

Scan the QR code on the right or visit engtechgroup.com/net-zero-initiatives/powerstar-calculator

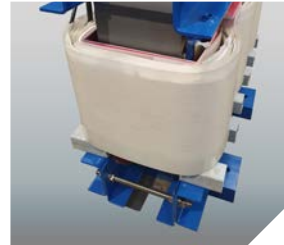

Complete core build.

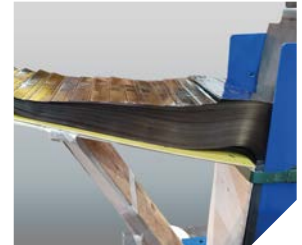

Amorphous core sheets at 25 microns thickness.



SCAN ME

Shown here is an example of cost and tCO₂e (Tons of Carbon Dioxide Equivalent) reductions when a 77 kVA Amorphous core transformer is fitted to a typical machine tool.

Financial Saving
from less energy

£34,040

Over 10 years*

Carbon
Reduction

43TCO2E

Over 10 years*

Take 10 minutes to create and publish your own Investment Policy to Prevent Global Warming, for free, through Betterworld.Solutions and receive...

£250 off your first Amorphous core transformer order

Visit www.betterworld.solutions/form



**Betterworld.
Solutions**



Making Engineers Champions...

+44 (0)1926 818 418



engtechgroup.com



sales@engtechgroup.com



THE ENGINEERING TECHNOLOGY GROUP

Wellesbourne Distribution Park, Unit 16
Loxley Road, Wellesbourne, Warwickshire, CV35 9JY

+353 (0)45 435457



etgireland.ie



salesireland@engtechgroup.com



THE ENGINEERING TECHNOLOGY GROUP - IRELAND

Unit 17, Newbridge Industrial Estate
Athgarvan Rd, Newbridge, Co. Kildare, Ireland

+44 (0)24 7699 3153



hyfore.com



sales@hyfore.com



HYFORE WORKHOLDING

Unit 3, 67 Blackhorse Road,
Longford, Coventry, CV6 6DP